



INTERSTAR





Move with confidence

Robust, reliable and effortlessly practical. The new Nissan Interstar keeps you one step ahead whatever the task. With a wide range of derivatives available, make yours the perfect tool for the job.



Key performance indicator

TWIN TURBO ENGINE

Power & efficiency. Interstar's 2.3L dCi Twin Turbo delivers higher output and reduced fuel consumption and lower CO₂ emissions*. Low costs of ownership. Service intervals of up to 25 000 miles or every 2 years contribute to Interstar's low running costs.

FRONT OR REAR WHEEL DRIVE

Select the drivetrain to best suit your business. Choose FWD for easy loading, more payload and better fuel economy or opt for RWD, with single or twin rear wheels, for an improved handling with heavier loads or when towing.



NEW NISSAN INTERSTAR CAN HANDLE IT

Benefit from maximum load space with 10 available cargo volumes, up to 4.4m in cargo length and payloads up to 1587kg (for Van) or up to 1,846kg (for Platform Cab)



Up to 4.4m
Cargo length

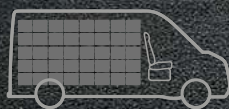

Up to 1587kg
Payload

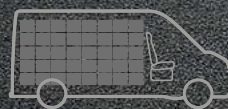

Up to 17m³
Cargo volume

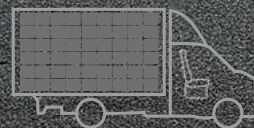

Up to 22m³
Cargo volume

BUILT FOR YOUR LINE OF WORK

With a wide range of conversions available, make new Nissan Interstar the perfect tool for your business. Choose from an array of body types, sizes, wheelbases and payload capacities, and create the ideal vehicle for your business' needs.



Panel



Box Van



Platform



Chassis



Tipper



Dropside



HELPFUL TECHNOLOGY

Enjoy an easier drive thanks to Nissan's advanced technology. Useful and simple to operate, it's designed to enhance your experience on the road.

Climate Control**

Cruise Control & Speed Limiter**

Front and Rear Parking Sensors and Rear View Camera**

NissanConnect**

Auto High Low Beam**

Lane Departure Warning**

Android Auto and Apple CarPlay**

**Features available depending on version and grade, as standard or only as option (at an extra charge)





Create the perfect match

Unbeatable potential. New Nissan Interstar offers one of the widest ranges in the LCV market. A choice of wheelbase, length and height, payload, engines, front or rear wheel drive plus body conversions provides all the possibilities you need to create your perfect match.



A place for everything

A tidy cab is safer and easier to live with nothing rolling around your feet, no wasted time hunting for items. That's why new Nissan Interstar has many clever storage spaces, such as the centre front seat table with a standard fix tray or an optional rotating tray and pop-up tablet.



Rotating centre front seat table*



Dual split underseat storage compartment*

*Features available depending on version, as standard or only as option (at an extra charge)

New Nissan Interstar can take it

More usable space. Whichever size Interstar you choose, it's packaged to provide maximum load space. There are ten cargo volumes, from 8m³ to 17m³ for Interstar Panel Vans. Cargo volume can take up to 5 Europallets, and there's up to 4.4m cargo length available, giving you room for bulky loads.

New Nissan Interstar handles heavy loads too: payloads up to 1,587kg (for Van) or up to 1,846kg (for Platform Cab).

No matter how big or awkward your cargo, Interstar makes it easier to get on board, thanks to a low floor and large, wide-opening doors.



From 2.6m
to 4.4m
cargo length

From 901kg
to 1,587kg
payload

From 8m³
to 17m³
cargo volume





FRONT WHEEL DRIVE

Front wheel drive new Nissan Interstar has a low chassis height, making loading especially easy and liberating more space for improved efficiency. Low kerb weight contributes to better fuel economy too.





Front or rear wheel drive

Best for your business. New Nissan Interstar gives you the choice of front or rear wheel drivetrains, across a variety of body styles.



REAR WHEEL DRIVE

Rear wheel drive is the traditional choice for medium and heavy duty applications. It allows your payload to be evenly distributed front to back, ensuring an improved handling when fully loaded. Available with single or twin rear wheel configurations, new Nissan Interstar rear wheel drive is ideal for towing up to 3,500 Kg.





INTERSTAR

Higher output, lower consumption, reduced emissions

More powerful, more efficient. The new Nissan Interstar's 2.3 litre dCi Twin Turbo engine is available in 110HP, 135HP, 150HP, 180HP with Euro6D-Full homologation and in 145HP or 165HP with EuroVIe homologation. All delivering outstanding performance with great fuel economy (up to 32.8 MPG on 150HP FWD, WLTP combined). All engines are EURO 6D compliant featuring a selective catalytic reduction (SCR) system to further reduce emissions. Low running costs. Service intervals of up to 25 000 miles or every two years contribute to Interstar's impressively low Total Cost of Ownership.

Always be in the optimum gear. The new Nissan Interstar has a six-speed manual gearbox with a dashboard indicator light showing when to change gear for the best fuel economy. If you want to give your left foot a rest, a semi-automatic robotised transmission is available with the 150HP or 180HP engines.



Euro 6D compliant
2.3 Litre dci turbodiesel



Six-speed manual
gearbox



Gear shift indicator

Eyes all round

Front and rear parking sensors* are just one of many intelligent driving assistance systems available on the new Nissan Interstar. While manoeuvring at low speed, the system detects objects in your path, both front and rear, and warns you as you get closer to them.



LANE DEPARTURE WARNING*

Lane Departure Warning provides an alert to the driver if they are beginning to leave the traveling lane. The system visually monitors the left and right side lane markers of the traveling lane. If there is a risk of the vehicle leaving the traveling lane unintended, the system flashes an indicator and sounds a warning chime.



BLIND SPOT WARNING*

Assists the driver to avoid a collision by detecting vehicles in the blind spot area when changing lanes. When the system detects a vehicle driving in an adjacent lane approaching the rear of the driver's vehicle - a common blind spot area, it notifies the driver with an indicator.



AUTO HIGH LOW BEAM*

Automatically switches headlights to low beam from high beam and back to reduce driving burden. This system automatically switches the headlights setting to low beam from high beam when it detects a vehicle ahead. Frequent usage of high beams allows for earlier detection of pedestrians, supporting safer driving.



SIDE WIND ASSIST*

Side wind assist technology detects sway caused by gusts of wind from the side when the vehicle is driving in a straight line and limits the side movement by correcting the trajectory.



HILL START ASSIST*

Assisting starting off on a slope. This technology allows drivers to change pedals easily from the brake to the accelerator and carry out a safer hill start.



INTELLIGENT TRACE CONTROL*

It automatically stabilises the vehicle by applying braking to each wheel individually and reducing engine torque if necessary. It uses sensors to measure the turning speed of the wheels, the steering angle and the rotation of the vehicle around the vertical axis.



Rear view camera*



Rear View Camera with display in mirror*



Blind spot mirror



Driver and passenger airbags

* Features available depending on version, as standard or only as option (at an extra charge)

You should not rely solely on driver convenience features. Some features may not work in all conditions and circumstances.

Speed and other limitations apply. For terms and conditions relating to Nissan technologies, please contact your Nissan dealer or www.nissan.co.uk



INTERSTAR

Easier driving. Helpful technology.

Nissan's approach to innovation is to take the most advanced and useful features and make them more accessible to everyone. Our technology is simple to operate, so driving becomes safer and more enjoyable. Standard digital radio improves the sound quality and enhances the listening experience.



androidauto

Works with
Apple CarPlay

© 2019 Nissan North America, Inc.



NissanConnect:
7 inch touch screen*



Digital radio (DAB) tuner and
MP3, bluetooth hands-free
telephone*



Usb 2.0 Socket*



Climate control*



Cruise control and speed
limiter*



Front foglamps*



Automatic headlights turn on
in low light and darkness*



Central door locking with
keyless entry*

* Features available depending on version and grade, as standard or only as option (at an extra charge)



Adapt new Nissan Interstar to fit your working day

You know what's best for your business. That's why we offer a range of practical options for you to tailor new Nissan Interstar precisely to your needs. Whatever your working day entails, new Nissan Interstar will be ready for it.

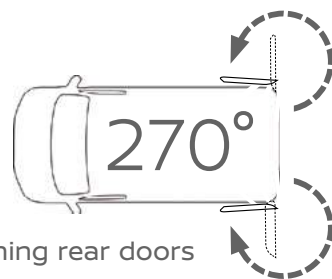

270° Opening rear doors



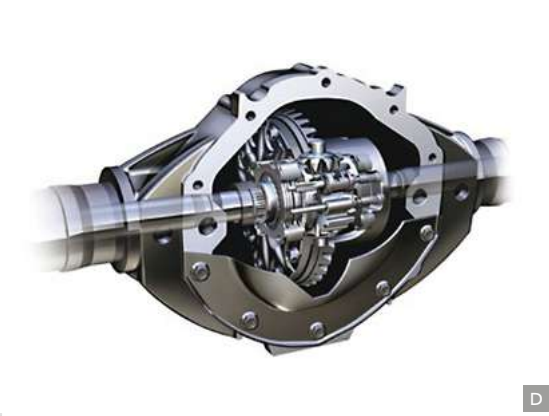

D



E



F

G



A

Full steel bulkhead*

B

Full steel bulkhead with glazed panel*

C

Driver's side meshed bulkhead*

D

Locking differential*

E

Rear step*

F

Towbar with ball and socket joint*

G

Power take-off from engine and gearbox*

* Features available depending on version and grade, as standard or only as option (at an extra charge)

Conversion, new Nissan Interstar lineup Ready for business

Thanks to the low and robust chassis, new Nissan Interstar is the ideal basis for a wide range of conversions. Nissan is always seeking ways to help you drive your business forward, that's why we have developed Business Ready solutions. NISSAN BRANDED CONVERSIONS are off-the-shelf bodies designed by Nissan and covered by our 5 year warranty. You can benefit from best lead times since you won't need to contact any Body builder yourself. Whether you need a Dropside, a Tipper or a Box van, your Business Ready Manager at your nearest Nissan dealer will see your order through, from selection to delivery to ongoing maintenance. Easy-to-order: having one point of contact makes life simple, easier and saves your precious time. If you want to tailor the New Nissan dealer to learn about the vast conversion offers that can be performed by our Nissan Certified Partner body builders.



▲
TIPPER



▲
DROPSIDE



▲
BOX VAN



5 Year / 100 000 miles (whatever comes first) Manufacturer Warranty for the whole LCV range, including Nissan branded conversion models.



Added value

Customise your Nissan Interstar. From seat covers, protective mats and mudguards to useful additions like a ladder, towbar or roof rack and walkway, Genuine Nissan Accessories make life easier.



TRANSPORT

- 1 - Ladder
- 2 - Flanged towbar with tek 7 or 13 pins and with hook and ball (also available with coupling hook or coupling jaw pin ball)
- 3 - Cross bars
- 4 - Roof rack and walkway

COMFORT AND PROTECTION

- 5 - Protection grill
- 6 - Textile or rubber mats
- 7 - Mudguards
- 8 - Seat covers

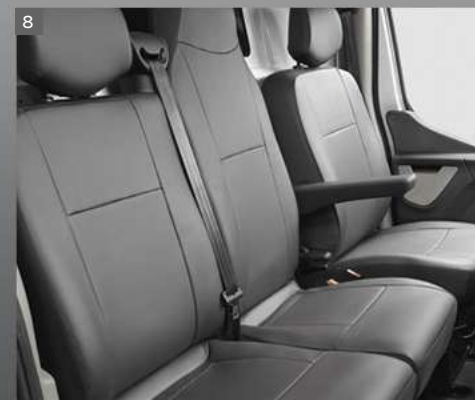
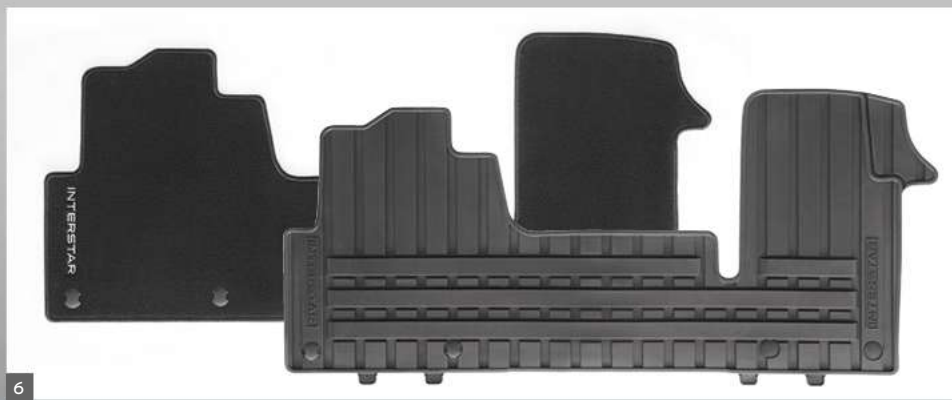
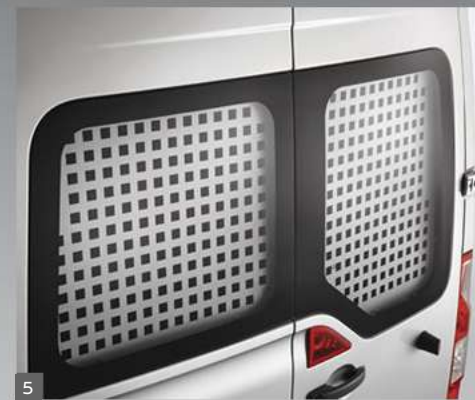

COLOURS



Silver (M)
KNH



Blue Grey (M)
J47



Black (M)
Z11/676



Urban Grey (S)
GRU/KPW



Volga Blue (S)
VBL/RNQ



Blaze Red (S)
Z52/719



Mineral White (S)
QNG

M: METALLIC
S: SOLID

TRIMS



Dark Grey
Standard

WHEELS



Hubcaps
(FWD Visia grade)



Small wheel covers
(RWD all grades)



Large wheel covers
(FWD Acenta/Tekna/
Tekna+ grades)

STANDARD FEATURES

KEY FEATURES THAT COME AS STANDARD

SAFETY AND SECURITY

- ABS with brake assist
- Remote central door locking with 2-button key
- Deadlocks
- Alarm
- Driver Airbag
- Spare wheel
- Nissan Anti-Theft System Immobiliser
- Blind spot mirror in passenger sunvisor

COMFORT AND CONVENIENCE

- Electrically adjustable & heated door mirrors
- Front electric windows
- 80-litre fuel tank
- 2 cup holders on dashboard

AUDIO AND NAVIGATION

- 2 speakers
- AUX socket
- USB port
- Bluetooth telephone integration
- FM/DAB audio system

TECHNOLOGY

- Vehicle Dynamic Control (VDC) + ASR
- Power steering
- Hill Start Assist
- Trailer Sway Assist

EXTERIOR STYLING

- Black bumpers (front & rear)
- 16" Steel Wheels with hub caps

INTERIOR STYLING

- Driver seat with longitudinal & height adjustment, backrest inclination and lumbar adj
- Driver and passenger sun visor
- 2-seater front row passenger bench seat
- Closed glove box
- Foldable central seat back with fixed table
- Overhead parcel shelves

PANEL VAN

VISIA GRADE

IN ADDITION TO STANDARD FEATURES

EXTERIOR STYLING

- Nearside sliding panel door
- 50:50 split 180 degree unglazed twin rear french doors
- Rear bumper with step (RWD only)

CARGO AREA

- Full steel bulkhead without fixed window
- Anchorage rings on floor (6 on L1/L2/L3, 8 on L4)

ACENTA GRADE

IN ADDITION TO VISIA GRADE

SAFETY AND SECURITY

- Remote central door locking with 3-button
- Passenger airbag

EXTERIOR STYLING

- Rear bumper with step (FWD and RWD)
- Full wheel covers (FWD versions only)

INTERIOR STYLING

- Soundproofing trim on bulkhead

COMFORT AND CONVENIENCE

- 105 litre fuel tank
- Trip computer
- 3,500kg towing capacity (RWD Twin Wheels only)

TECHNOLOGY

- Rear parking sensors
- Cruise control and speed limiter

CARGO AREA

- Anchorage rings on floor and on C&D pillars (6 on L1/L2/L3, 10 on L4)
- 12V socket in cargo area

OPTIONS*

- Offside sliding panel door

TEKNA GRADE

IN ADDITION TO ACENTA GRADE

COMFORT AND CONVENIENCE

- Manual air-conditioning with pollen filter
- NissanConnect 7" multimedia system with Android Auto / Apple CarPlay
- Satellite Navigator

INTERIOR STYLING

- Foldable central seat back with rotating table and storage under cushion

EXTERIOR STYLING

- 50:50 split 270 degree unglazed twin rear french doors

SAFETY AND SECURITY

- Front fog lights
- Automatic headlights
- Automatic windscreen wipers
- Rear view camera
- Front & rear parking sensors

TEKNA+ GRADE

IN ADDITION TO TEKNA GRADE

SAFETY AND SECURITY

- Lane Departure Warning
- Auto high low beam
- Blind spot detection

*Options available at an additional cost

DROPSIDE

ACENTA GRADE

IN ADDITION TO STANDARD FEATURES

EXTERIOR STYLING

- Full wheel covers (FWD versions only)
- Towbar: single ball with 13 pin plug socket (FWD versions only)
- Protection under engine (FWD versions only)
- Rear ladder rack (FWD versions only)

SAFETY AND SECURITY

- Passenger airbag

TECHNOLOGY

- Wiring harness with 6-way connector located under the dashboard (for bodybuilders usage)
- Cruise control and speed limiter

COMFORT & CONVENIENCE

- 3,500kg towing capacity (RWD twin wheel only)
- Driver's sprung seat- replaces standard seat (FWD versions only)
- Manual air conditioning (FWD versions only)

CARGO AREA

- Full glazed partition

TEKNA GRADE

IN ADDITION TO ACENTA GRADE

SAFETY AND SECURITY

- Front fog lights
- Automatic headlights
- Automatic windscreen wipers

INTERIOR STYLING

- Foldable central seat back with rotating table and storage under cushion

COMFORT AND CONVENIENCE

- Manual air conditioning with pollen filter
- NissanConnect 7" multimedia system with Android Auto / Apple CarPlay
- Satellite Navigation

TEKNA+ GRADE

IN ADDITION TO TEKNA GRADE

SAFETY AND SECURITY

- Lane Departure Warning
- Auto Low/High Beam

CHASSIS

ACENTA GRADE

IN ADDITION TO STANDARD FEATURES

EXTERIOR STYLING

- Extended door mirror arms
- Full wheel covers (FWD versions only)

SAFETY AND SECURITY

- Passenger airbag

TECHNOLOGY

- Wiring harness with 6-way connector located under the dashboard (for bodybuilders usage)
- Cruise control and speed limiter

COMFORT & CONVENIENCE

- 3,500kg towing capacity (RWD twin wheel only)

CARGO AREA

- Full glazed partition

TEKNA GRADE

IN ADDITION TO ACENTA GRADE

SAFETY AND SECURITY

- Front fog lights
- Automatic headlights
- Automatic windscreen wipers

INTERIOR STYLING

- Foldable central seat back with rotating table and storage under cushion

COMFORT AND CONVENIENCE

- Manual air conditioning with pollen filter
- NissanConnect 7" multimedia system with Android Auto / Apple CarPlay
- Satellite Navigation

TEKNA+ GRADE

IN ADDITION TO TEKNA GRADE

SAFETY AND SECURITY

- Lane Departure Warning
- Auto Low/High Beam

TIPPER

ACENTA GRADE

IN ADDITION TO STANDARD FEATURES

INTERIOR STYLING

- Full wheel covers (FWD versions only)

TECHNOLOGY

- Wiring harness with 6-way connector located under the dashboard (for bodybuilder's usage)
- Cruise control and speed limiter

COMFORT & CONVENIENCE

- 3,500kg towing capacity (RWD Twin Wheels only)

CARGO AREA

- Full glazed partition
- Toolbox (Compatible with L3 variant only)

SAFETY AND SECURITY

- Passenger airbag

TEKNA GRADE

IN ADDITION TO ACENTA GRADE

SAFETY & SECURITY

- Front fog lights
- Automatic headlights
- Automatic windscreen wipers

COMFORT AND CONVENIENCE

- Manual air-conditioning with pollen filter
- NissanConnect 7" multimedia system with Android Auto / Apple CarPlay
- Satellite Navigator

TEKNA+ GRADE

IN ADDITION TO TEKNA GRADE

SAFETY AND SECURITY

- Lane Departure Warning
- Auto high low beam

PLATFORM

ACENTA GRADE

IN ADDITION TO STANDARD FEATURES

EXTERIOR STYLING

- Extended door mirror arms
- Full wheel covers (FWD versions only)

SAFETY AND SECURITY

- Passenger airbag

COMFORT AND CONVENIENCE

- Trip computer

CARGO AREA

- Full glazed partition

TECHNOLOGY

- Cruise control and speed limiter

OPTIONS*

- Pneumatic suspension

TEKNA GRADE

IN ADDITION TO ACENTA GRADE

SAFETY AND SECURITY

- Front fog lights
- Automatic headlights
- Automatic windscreen wipers

COMFORT AND CONVENIENCE

- Manual air-conditioning with pollen filter
- NissanConnect 7" multimedia system with Android Auto / Apple CarPlay
- Satellite Navigation

OPTIONS*

- Pneumatic suspension

TEKNA+ GRADE

IN ADDITION TO TEKNA GRADE

SAFETY AND SECURITY

- Lane Departure Warning
- Auto high low beam

Front wheel drive panel van

Front wheel drive new Nissan Interstar delivers what your business needs: greater efficiency. A lower kerb weight helps improve fuel economy, reducing your running costs. The low frame height makes loading easier and allows a bigger payload. It's the Van that gives you more, but demands less.

WEIGHTS AND LOADS

	Max. cargo volume (m ³)	Max. payload (kg)		
		2.8t	3.3t	3.5t
L1H1	8	901	1396	1587
L1H2	9	883	1378	1570
Max. weight on front / rear axle		1850 / 1650	1850 / 2100	1850 / 2100
Braked / unbraked trailer capacity		2500 / 750		

	Max. cargo volume (m ³)	Max. payload (kg)	
		3.3t	3.5t
L2H2	10.8	1322	1522
Max. weight on front / rear axle		1850 / 2100	1850 / 2100
Braked / unbraked trailer capacity		2500 / 750	

	Max. cargo volume (m ³)	Max. payload (kg)	
		3.5t	
L3H2	13	1432	
L3H3	14.8	1423	
Max. weight on front / rear axle		1850 / 2100	
Braked / unbraked trailer capacity		2500 / 750	

DIMENSIONS (mm)

	L1H1	L1H2	L2H2	L3H2	L3H3
Min. turning circle between kerbs / walls	12 / 12.5m		13.6 / 14.1m	15.7 / 16.2m	
CARGO AREA					
Cargo length on floor (A)	2583	2583	3083	3733	3733
Cargo length at 1.1m above floor	2530	2530	3030	3680	3680
Cargo width (B)	1765	1765	1765	1765	1765
Width between wheelarches (C)	1380	1380	1380	1380	1380
Cargo height	1700	1894	1894	1894	2144
Min. / max. loading sill height	546 / 564	544 / 563	545 / 562	543 / 557	542 / 555
SLIDING DOORS					
Sliding door width	1050	1050	1270	1270	1270
Sliding door height	1581	1780	1780	1780	1780
REAR DOOR					
Rear door width at 169mm above floor	1580	1580	1580	1580	1580
Rear door height	1627	1820	1820	1820	1820

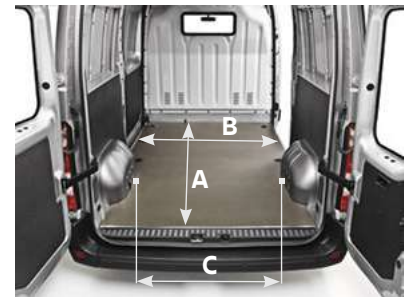
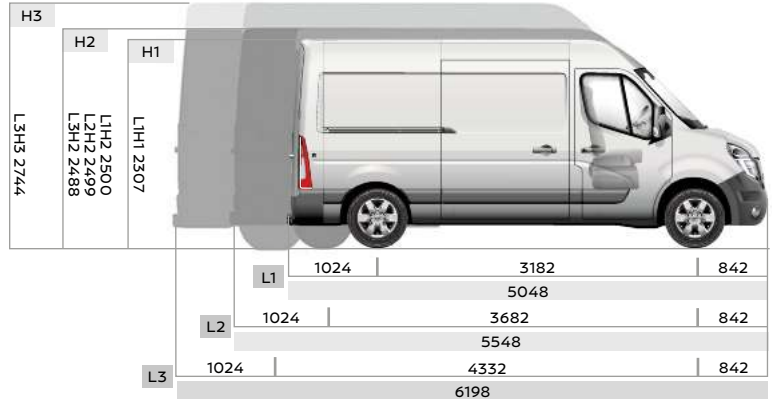

Kerb weight includes fluids and fuel tank 90% full and excludes the driver (75kg). Payload is calculated as the difference between gross vehicle weight (GVW) and kerb weight. Kerb weight is affected by factors such as body styles and options. The weight figures in the table are related to a standard-specification vehicle according to type approval data. Any additional options specified on the vehicle will increase its kerb weight and reduce its payload accordingly. All weight figures are subject to 5% manufacturing tolerances.

Rear wheel drive panel van

Rear wheel drive new Nissan Interstar offers practical versatility, with the capacity and strength to handle all your medium duty carrying applications. Its Rear Wheel Drive layout creates optimum front-to-rear balance, for better payload distribution. It also ensures surefooted and stable driving characteristics when fully loaded, and makes it ideally suited for towing.

WEIGHTS AND LOADS

	Max. cargo volume (m ³)	Max. payload (kg)	
		3.5t SRT	3.5t DRT
L3H2	12.4	1207	1151
L3H3	14.2	1189	1128
Max. weight on front / rear axle		1850 / 2300	1850 / 2800
Braked / unbraked trailer capacity		2500 / 750	3500 / 750

	Max. cargo volume (m ³)	Max. payload (kg)	
		3.5t SRT	3.5t DRT
L4H2	14.9	1207	1111
L4H3	170	1160	1040
Max. weight on front / rear axle		1850 / 2300	1850 / 2800
Braked / unbraked trailer capacity		2500 / 750	3500 / 750

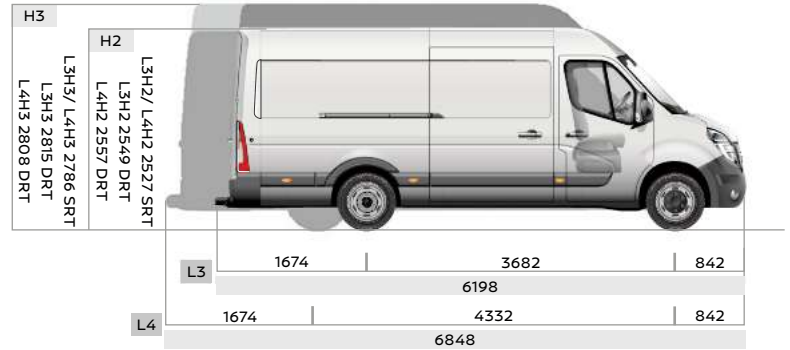

DIMENSIONS (mm)

		L3H2 SRT	L3H2 DRT	L3H3 SRT	L3H3 DRT	L4H2 DRT	L4H3 DRT
Min. turning circle between kerbs / walls		12.4		14.2		14.9	17
		3.5t	3.5t	3.5t	3.5t	3.5t/3.5t	
Max. Turning circle (Wall to wall)	m	14.1	14.1	14.1	14.1	16.2	16.2
Min. Turning Circle (Kerb to Kerb)	m	13.6	13.6	13.6	13.6	15.7	15.7
CARGO AREA							
Cargo length on floor (A)		3733	3733	3733	3733	4383	4383
Cargo length at 1.1m above floor		3680	3680	3680	3680	4330	4330
Cargo width (B)		1765	1765	1765	1765	1765	1765
Width between wheelarches (C)		1380	1080	1380	1080	1080	1080
Cargo height		1798	1798	2048	2048	1798	2048
Min. / max. loading sill height		674 / 696	706 / 724	672 / 694	704 / 723	701 / 717	700 / 715
SLIDING DOORS							
Sliding door width		1270	1270	1270	1270	1270	1270
Sliding door height		1684	1684	1684	1684	1684	1684
REAR DOOR							
Rear door width at 169mm above floor		1580	1580	1580	1580	1580	1580
Rear door height		1724	1724	1724	1724	1724	1724

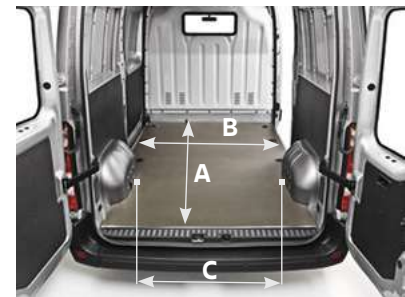

- SRT: Single Rear Tyres
- DRT: Double Rear Tyres

Kerb weight includes fluids and fuel tank 90% full and excludes the driver (75kg). Payload is calculated as the difference between gross vehicle weight (GVW) and kerb weight. Kerb weight is affected by factors such as body styles and options. The weight figures in the table are related to a standard-specification vehicle according to type approval data. Any additional options specified on the vehicle will increase its kerb weight and reduce its payload accordingly. All weight figures are subject to 5% manufacturing tolerances.

Front wheel drive chassis cab

New Nissan Interstar Chassis Cab offers the flexibility and adaptability to satisfy your exact specifications. Whichever drive train you choose, you benefit from a low chassis floor that provides more usable space for your conversion, within compact and manageable overall dimensions. And the rugged build quality ensures it has the strength to cope with the toughest jobs, all day, every day.

WEIGHTS AND LOADS (kg)		
	SINGLE CAB	
	L2	L3
	3.5T	3.5T
Max. payload	1739	1718
Max. weight on front / rear axle	1850 / 2100	
Braked / unbraked trailer capacity	2500 / 750	

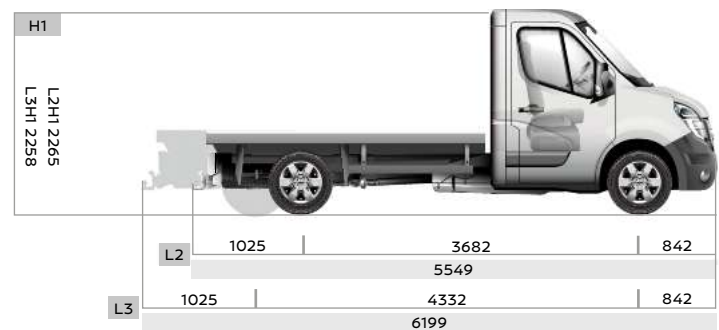

DIMENSIONS (mm)		
	SINGLE CAB	
	L2	L3
Min. turning circle between kerbs / walls	13.6 / 14.1m	15.7 / 16.2m
Max. extension of rear overhang	1400	2124
Max. buildable overall length	5924	7298
Min. / max. buildable cargo length	3182 / 3464	3832 / 4838
Min. / max. floor height	735 / 740	736 / 741
Max. buildable width including standard/ extended door mirrors arms	2170 / 2350	2170 / 2350

- SRT: Single Rear Tyres
 - DRT: Double Rear Tyres
 *With extended door mirror arms



Kerb weight includes fluids and fuel tank 90% full and excludes the driver (75kg). Payload is calculated as the difference between gross vehicle weight (GVW) and kerb weight. Kerb weight is affected by factors such as body styles and options. The weight figures in the table are related to a standard-specification vehicle according to type approval data. Any additional options specified on the vehicle will increase its kerb weight and reduce its payload accordingly. All weight figures are subject to 5% manufacturing tolerances.

Rear wheel drive chassis cab

WEIGHTS AND LOADS (kg)

	SINGLE CAB			
	L2		L3	L4
	3.5T SRT	3.5T DRT	3.5T SRT	3.5T DRT
Max. payload	1626	1435	1575	1430
Max. weight on front / rear axle	1850 / 2300	1850 / 2800	1850 / 2300	1850 / 2800
Braked / unbraked trailer capacity	2500 / 750	3500 / 750	2500 / 750	3500 / 750

DIMENSIONS (mm)

	SINGLE CAB				
	L2 SRT	L2 DRT	L3 SRT	L3 DRT	L4 DRT
Min. turning circle between kerbs / walls	13.6 / 14.1m		15.7 / 16.2m	13.6 / 14.1m	15.7 / 16.2m
Max. extension of rear overhang	2230	1928	3032	1928	2754
Max. buildable overall length	6754	6452	8206	6452	7928
Min. / max. buildable cargo length	3182 / 4293	3639 / 3991	3832 / 5746	3639 / 3991	4289 / 5468
Min. / max. floor height	771 / 774	784 / 787	771 / 775	784 / 787	786 / 789
Max. buildable width including standard / extended door mirrors arms	2170 / 2350	2170 / 2350	2170 / 2350	2170 / 2350	2170 / 2350

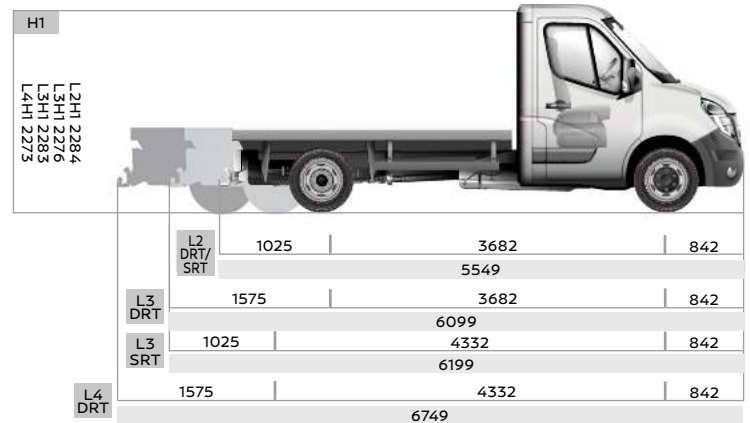

- SRT: Single Rear Tyres
- DRT: Double Rear Tyres
- *With extended door mirror arms

Kerb weight includes fluids and fuel tank 90% full and excludes the driver (75kg). Payload is calculated as the difference between gross vehicle weight (GVW) and kerb weight. Kerb weight is affected by factors such as body styles and options. The weight figures in the table are related to a standard-specification vehicle according to type approval data. Any additional options specified on the vehicle will increase its kerb weight and reduce its payload accordingly. All weight figures are subject to 5% manufacturing tolerances.

Tipper

Built for hard work with no compromise on in-cab comfort, the new Nissan Interstar Tipper is available with a single cab (2/3 seats), with the option of a secure storage compartment for tools. The load deck tilts automatically at 45° for quick and easy unloading.

PAYLOAD AND DIMENSIONS

	FWD
	SINGLE CAB
	L2 SRT
	3.5t
Max. payload (kg)	1242
Max. weight on front / rear axle (kg)	1850 / 2100
Braked / unbraked trailer capacity (kg)	2500 / 750
Cargo length ext. / int. (mm)	3280 / 3205
Cargo width (mm)	2100
Cargo height (mm)	400

	RWD		
	SINGLE CAB		SINGLE CAB + TOOLBOX
	L2 SRT	L2 DRT	L3 DRT
	3.5t	3.5t	3.5t
Max. payload (kg)	1129	959	845
Max. weight on front / rear axle (kg)	1850 / 2300	1850 / 2800	1850 / 2800
Braked / unbraked trailer capacity (kg)	2500 / 750	3500 / 750	3500 / 750
Cargo length ext. / int. (mm)	3280 / 3205		3180 / 3105
Cargo width (mm)	2100		
Cargo height (mm)	400		

FRONT WHEEL DRIVE



REAR WHEEL DRIVE

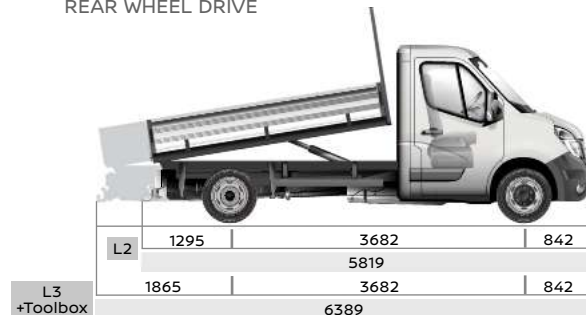

Toolbox between cabin and load deck not shown in the image



Dropside

Based on a robust chassis, the new Nissan Interstar Dropside combines a low loading height with fold-down side panels to make light work of even its maximum 3.5 ton Gross Vehicle Weight. Easy, all-round access to the load space makes it easier to handle large, heavy loads, available in single cab with 2/3 seats.

PAYLOAD AND DIMENSIONS		
	FWD	
	SINGLE CAB	
	L2 SRT	L3 SRT
	3.5t	
Max. payload (kg)	1399	1333
Max. weight on front / rear axle (kg)	1850 / 2100	
Braked / unbraked trailer capacity (kg)	2500 / 750	
Cargo length ext. / int. (mm)	3230 / 3170	3900 / 3840
Cargo width (mm)	2100	
Cargo height (mm)	400	

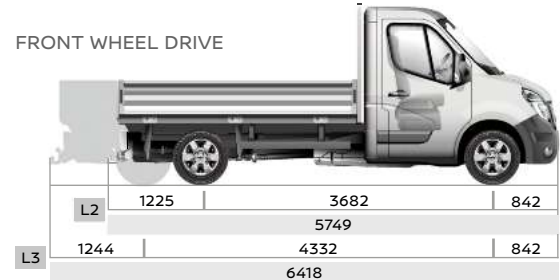

	RWD				
	SINGLE CAB				
	L2 SRT	L3 SRT	L2 DRT	L3 DRT	L4 DRT
	3.5t		3.5t	3.5t	3.5t
Max. payload (kg)	1214	1210	1112	1061	1020
Max. weight on front / rear axle (kg)	1850 / 2300		1850 / 2800	1850 / 2800	1850 / 2800
Braked / unbraked trailer capacity (kg)	2500 / 750		3500 / 750		
Cargo length ext. / int. (mm)	3230 / 3170	3900 / 3840	3230 / 3170	3780 / 3720	4430 / 4370
Cargo width (mm)	2100				
Cargo height (mm)	400				

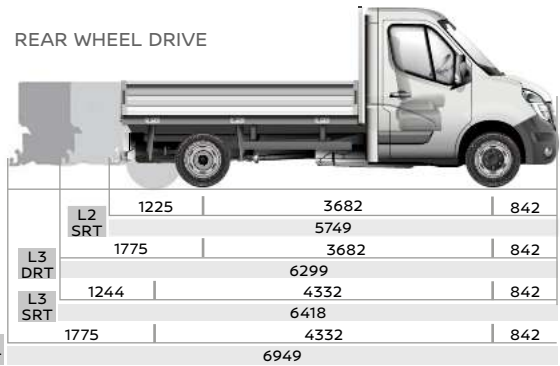

Kerb weight includes fluids and fuel tank 90% full and excludes the driver (75kg). Payload is calculated as the difference between gross vehicle weight (GVW) and kerb weight. Kerb weight is affected by factors such as body styles and options. The weight figures in the table are related to a standard-specification vehicle according to type approval data. Any additional options specified on the vehicle will increase its kerb weight and reduce its payload accordingly. All weight figures are subject to 5% manufacturing tolerances.

Box Van

The secure loadcarrier with a choice of capacities, up to 22m³ and 4.58m load length. This large, practical space makes the new Nissan Interstar Box ideal for removals or other bulky deliveries. Luton Van configuration available as option with additional loadspace over cabin.

PAYLOAD AND DIMENSIONS

	FWD		RWD	
	L3 20m ³	L3 SRT 20m ³	L4 DRT 20m ³	L4 DRT 22m ³
	3.5t	3.5t	3.5t	3.5t
Max. payload (kg)	1162	1012	834	848
Max. load (m ³)	19.4	19.4	20.3	21.7
Max. weight on front / rear axle (kg)	1850 / 2100	1850 / 2300	1850 / 2800	

	FWD / RWD		
	20m ³ L3	20m ³ L4	22m ³ L4
CARGO AREA (mm)			
Cargo length	4100	4300	4580
Cargo width	2150	2150	2150
Cargo height	2200	2200	2200
REAR DOORS (mm)			
Rear door width	2105	2105	2105
Rear door height	2165	2165	2165

FRONT WHEEL DRIVE



REAR WHEEL DRIVE



FWD



RWD



Kerb weight includes fluids and fuel tank 90% full and excludes the driver (75kg). Payload is calculated as the difference between gross vehicle weight (GVW) and kerb weight. Kerb weight is affected by factors such as body styles and options. The weight figures in the table are related to a standard-specification vehicle according to type approval data. Any additional options specified on the vehicle will increase its kerb weight and reduce its payload accordingly. All weight figures are subject to 5% manufacturing tolerances.

Platform cab

With its very low loading sill and over 7m of buildable overall length, new Nissan Interstar Platform Cab has impressive potential as the perfect base for a vast array of conversions, such as box van, catering vehicle or mobile shop.

WEIGHTS AND LOADS (kg)

	FWD 3.5T			
	L2H1	L2H2	L3H1	L3H2
Max. payload	1846	1833	1825	1806
Max. weight on front / rear axle	1850/2100			
Braked / unbraked trailer capacity	2500/750			

DIMENSIONS (mm)

	L2H1	L2H2	L3H1	L3H2
	Min. turning circle between kerbs / walls	13.6 / 14.1m	13.6 / 14.1m	15.7 / 16.2m
Max. buildable overall length	5751	5790	7021	7071
Min. / max. buildable cargo length	3069 / 3291	3069 / 3330	3719 / 4561	3719 / 4610
Max. buildable extension of rear overhang	1227	1266	1847	1897
Min. / max. floor height	581 / 585	581 / 584	579 / 583	579 / 583
Max. buildable width including standard / extended door mirrors arms	2170 / 2350	2170 / 2350	2170 / 2350	2170 / 2350

*With extended door mirror arms

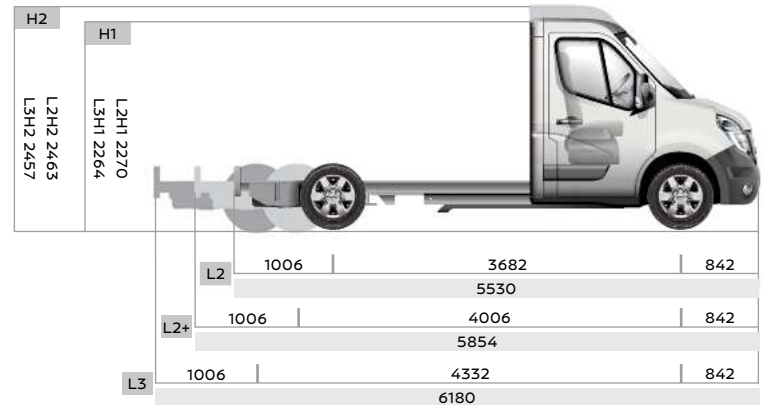

Kerb weight includes fluids and fuel tank 90% full and excludes the driver (75kg). Payload is calculated as the difference between gross vehicle weight (GVW) and kerb weight. Kerb weight is affected by factors such as body styles and options. The weight figures in the table are related to a standard-specification vehicle according to type approval data. Any additional options specified on the vehicle will increase its kerb weight and reduce its payload accordingly. All weight figures are subject to 5% manufacturing tolerances.

NISSAN LCV 5 YEAR MANUFACTURER WARRANTY

NISSAN now offers a standard 5 Year Pan-European Manufacturer Warranty on its whole LCV range*. This is much more than just a warranty as it includes:



- 5 Year or 100 000 miles bumper-to-bumper protection
- 5 Year NISSAN Genuine Parts & Accessories Warranty
- 5 Year Roadside Assistance
- Fully transferable

And with service intervals at 2 years or 25 000 miles for Diesel engines, you'll not only have 5 years of peace of mind but also low running costs into the bargain.



AT NISSAN, YOU BRING OUT THE BEST IN US.

You spark our imagination. You provoke our ingenuity. You inspire us to change the rules and innovate. And at Nissan, innovation is not just about additions and extensions; it's about crossing the line to reinvent the status quo. It's about developing unexpected solutions to satisfy your wildest and most pragmatic desires. At Nissan, we design vehicles, accessories and services that break the mould - making the practical exciting and the exciting practical to offer you a more exhilarating driving experience everyday.

*5 Year / 100 000 miles (whatever comes first) Manufacturer Warranty for the LCV range (with the exception of e-NV200: 5 Year / 60 000 miles Manufacturer Warranty for EV system parts, 3 Year / 60 000 miles for the rest of the vehicle)

Unlimited mileage for Nissan Genuine Parts & Accessories, Warranties and Roadside Assistance.

For more details, please refer to Nissan Warranty Booklet.

CUSTOMER SERVICES



SPECIALISED LCV NETWORK

NISSAN provides a specialised network of LCV dealerships to support your specific commercial vehicle requirements:

- Pan-European coverage
- Dedicated LCV Sales & After Sales staff
- Competitive financing solutions
- Tailor made conversion offers
- Competitive extended warranty offers to go even beyond NISSAN LCV 5 Year Warranty.
- Test drive your choice



AFTERSALES SERVICES

If your car breaks down, it's inconvenient. If your van breaks down, it's a serious blow to your business. Even time allowed for servicing is downtime, when your van isn't earning its keep. At Nissan, we understand these hard business facts. So we do the best to ensure that your van stays where it belongs – working for you, on the road.



NISSAN SERVICE CONTRACTS AND EXTENDED WARRANTY

For total peace of mind and budget control, you can subscribe to a Nissan Service Contract which will cover your periodic maintenance and Wear & Tear parts for the mileage and period that suits your business best. This way, you can ensure that your new Nissan Interstar is serviced by dedicated Nissan technicians. And for even more serenity, you can get an Extended Warranty to cover possible mechanical and electrical breakdown after the end of your new Nissan Interstar warranty.



5 YEAR ROADSIDE ASSISTANCE

- Pan-European coverage for breakdowns, accidents, non-warrantable incidents (such as flat tyres, lost keys, wrong fuel...)
- 24/7, 365 days
- Emergency Call Centre
- Prompt roadside assistance

If this is not possible and your vehicle is still immobilised after a few hours, we will make sure you are provided with a courtesy vehicle as soon as possible or if necessary, overnight accommodation and travel to your onward destination or back to your base. We will also recover your immobilised vehicle.



Nissan Intelligent Mobility moves you one step ahead. In vehicles that feel like an extension of you, helping you see more and sense more, reacting with you, and sometimes even for you. Nissan Intelligent Mobility is about a better future – moving us to a world that's safer, more sustainable, and exciting.

Deep dive in New Nissan Interstar experience: www.nissan.co.uk/vehicles/new-vehicles/nissan-interstar

Follow Nissan Interstar on Facebook, Twitter and Youtube.

Every effort has been made to ensure that the content of this publication is correct at the time of going to press (March 2023). This brochure has been produced featuring prototype vehicles exhibited at motor shows. In accordance with the company's policy of continuously improving its products, Nissan Europe reserves the right to change at any time the specification and the vehicles described and shown in this publication. Nissan dealers will be informed of any such modifications as quickly as possible. Please check with your local Nissan dealer to receive the most up-to-date information. Because of the limitations of the printing processes used, the colours shown in this brochure may differ slightly from the actual colours of the paint and interior trim materials used.

All rights reserved. Reproduction in whole or part of this brochure without the written permission of Nissan Europe is forbidden. This brochure is made from chlorine free paper – MY22 Interstar brochure 03/2023 – Printed in EU. Created by DESIGNORY, France and produced by eg+ worldwide, France – Tel: +33 1 49 09 25 35.